

FELCO 13 - Green

Pruning shear - High performance - Use with 1 or 2 hands

Made in Switzerland by FELCO



- > **Reliable:** comfortable, light, sturdy handles made of forged aluminium with a lifetime guarantee* / blade and screw-mounted anvil blade made of high-quality hardened steel / clean, precise cut / all parts can be replaced
- > **Efficient:** easy, durable cutting adjustment / wire cutting notch / sap groove
- > **Ergonomic:** hand and wrist protection and optimisation of the force exerted are provided by the angled head, the ideal shape of the handles, and the cushion-shock absorber / non-slip coating



RECOMMENDED FOR

Our recommendation (★ = Recommended, ★★ = Strongly recommended, ★★★ = Best fit)

Viticulture	★★★
Arboriculture	★★★
Horticulture	★★★
Parks and Gardens	★★★
Small hand	★★★
Average-sized hand	★★★
Large hand	★★★
Left-handed	★★★

THE POINTS OF EXCELLENCE



Wire cutting notch

The blades feature a notch that allows for the cutting of small wires without damaging the cutting edge.



Sap groove

The sap groove prevents the blade sticking when cutting "sappy" wood. It saves time and makes pruning easier by removing sap and debris after each cut.



Micrometric adjustment

FELCO's micrometric adjustment system guarantees an optimal adjustment of the cutting head throughout the life of the tool. It ensures a clean and precise cut.



Shock absorption system

The cushion and shock absorber soften the impact upon finishing cutting. The hand and wrist are also protected.



Forged aluminum handles

Lightweight, strong and sturdy thanks to special aluminum alloys and advanced precision forging methods. Equipment comes with a lifetime guarantee*.

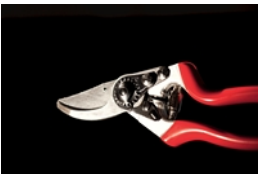

Angled cutting head

Inclined cutting head to reduce the risk of muscular-skeletal injuries and to maximise user comfort.



Use with one or two hands

Helpful lever arm reducing effort by 25%. The extra-long handle allows use with either one or two hands.

ACCESSORIES



FELCO 902
Sharpening tool
Sharpening stone



FELCO 903
Sharpening tool
Sharpener











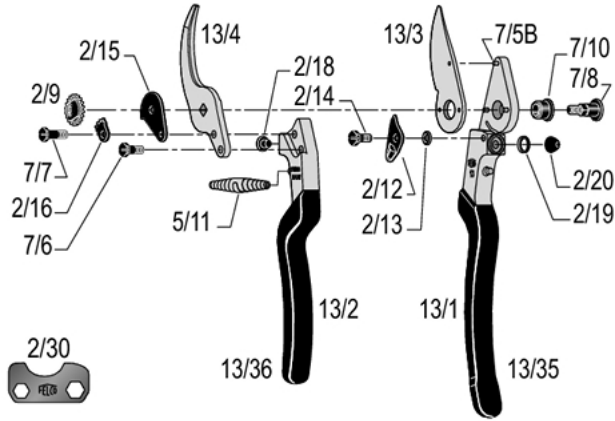









FELCO 980
Maintenance product
Spray







































FELCO 990
Maintenance product
Grease

SPARE PARTS



FELCO	REF.	Designation	Composition	UCC Barcode
	2/30	Adjustment key	1x 2/30	
	13/3	Blade	1x 13/3	
	13/4	Anvil-blade with screw	1x 13/4 + 1x 7/6	
	7/90	Kit	1x 7/7 + 1x 2/16 + 1x 2/9 + 1x 7/8	
	5/91	Kit	2x 5/11	
	2/92	Kit	1x 2/15 + 1x 2/18 + 1x 2/14 + 1x 2/12 + 1x 2/13 + 1x 2/20	
	2/93	Kit	4x 2/18 + 6x 2/20	
	7/94	Kit	1x 2/9 + 1x 7/8	
	13/1	Handle without blade	1x 13/1 + 3x 7/5B + 1x 2/19 + 1x 2/20 + 1x 7/10 + 1x 2/13 + 1x 2/12 + 1x 2/14 + 1x 13/35	

	13/2	Handle without anvil-blade	1x 13/2 + 1x 2/18 + 1x 13/36	
	13/35	Coating for blade handle	1x 13/35	
	13/36	Coating for blade handle	1x 13/36	
	7/5B	Rivet for blade	1x 7/5B	
	7/6	Screw for anvil-blade	1x 7/6	
	7/8	Bolt	1x 7/8	
	2/9	Nut	1x 2/9	
	7/10	Bush	1x 7/10	
	5/11	White spring	1x 5/11	
	2/12	Thumb catch	1x 2/12	
	2/13	Spring for thumb catch	1x 2/13	
	2/14	Screw for thumb catch	1x 2/14	
	2/15	Catch plate	1x 2/15	
	2/16	Locking segment	1x 2/16	
	7/7	Screw for locking segment	1x 7/7	

	2/18	Cushion	1x 2/18	 7 83929 40159 1
	2/19	Edging	1x 2/19	 7 83929 40160 7
	2/20	Shock absorber	1x 2/20	 7 83929 40162 1

MAINTENANCE



Cleaning

It is advisable to clean your tool after each use.

If your tool is particularly dirty or subject to rusting after exposure to moisture, do not delay cleaning.



Oiling

After cleaning, it is advisable to oil the tool so as to protect it from corrosion. The oil will also unjam the tool.



Sharpening

It is advisable to sharpen your tool at least once a day, but if you feel that your tool is not cutting as well as usual, sharpen it right away!



Dismantling

It is advisable to dismantle your tool on a regular basis, but at the very latest when it appears to be jammed.

PARTS REPLACEMENT



Changing the blade

When the blade and the anvil-blade no longer cross, or when the blade is badly damaged, it is advisable to change it.

Regulate the working of the blade and anvil-blade by adjusting the tightening of the nut. The blade should rub against the anvil-blade over 2/3 of its length.



Changing the anvil-blade

When the blade and anvil-blade no longer cross and the anvil-blade is badly damaged, it is advisable to change it.



Changing the shock absorber

When the tool closes too abruptly during pruning, and the cushion is in good condition, the shock absorber should be changed.



Changing the cushion

When the tool closes too abruptly during pruning and the shock absorber is in good condition, the cushion must be changed.



Changing the thumb catch

When the thumb catch is damaged and loosens when used, even when the screw is readjusted, change it.



Changing the plastic coatings for handles

If the coatings are badly damaged, you can replace them.

Soak the coatings for 2 minutes in boiling water - recommended glue: Loctite 415.