

## FELCO 231 - Green

Two-hand pruning shear - Lever-action lopper with curved anvil -Length 80 cm (31.5 in.)- for easier cutting  
Made in Switzerland by FELCO



40mm/1.6in. 800mm/31.5in. 1150g/40.5oz.



- > **Reliable:** rigid, high-resistance tubular aluminium alloy handles / protected lever system / tough tempered steel blade and replaceable anvil made of high-grade forged aluminium / clean and precise cut / spare parts
- > **Efficient:** optimised lever system for effortless cutting / easy tool adjustment / cutting head with curved anvil / hollow-ground blade that minimises cutting effort
- > **Ergonomic:** ultra-light tool / effortless cutting / safety stop that prevents finger pinching / handles with non-slip coating

## RECOMMENDED FOR

Our recommendation (★ = Recommended, ★★ = Strongly recommended, ★★★ = Best fit)

Arboriculture	★★★
Parks and Gardens	★★★
Small hand	★★★
Average-sized hand	★★★
Large hand	★★★
Left-handed	★★★

## THE POINTS OF EXCELLENCE



### Cutting head with curved anvil

The cutting head with curved anvil keeps the branch close to the central axis of the cutting head. The hollow-ground blade guarantees easier cutting. Ideal for hard or dry wood.



### Cam-assisted action

The cam-assisted action greatly reduces the effort required to cut through the wood.



### Aluminium handles

Lightweight, super-strong materials.

**ACCESSORIES**



FELCO 903  
Sharpening tool  
Sharpener











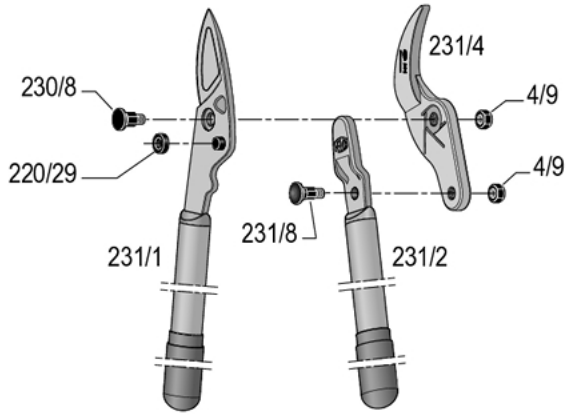





FELCO 980  
Maintenance product  
Spray



FELCO 990  
Maintenance product  
Grease

**SPARE PARTS**



FELCO	REF.	Designation	Composition	UCC Barcode
	231/4	Anvil with nuts	1x 231/4 + 2x 4/9	 7 83929 40114 0
	231/1	Handle with blade	1x 231/1	 7 83929 40118 8
	231/2	Handle without anvil	1x 231/2	 7 83929 40119 5
	230/8	Bolt	1x 230/8	 7 83929 40189 8
	231/8	Bolt	1x 231/8	 7 83929 40190 4
	4/9	Nut	1x 4/9	 7 83929 40205 5
	220/29	Roller	1x 220/29	 7 83929 40187 4